

# SELF-LUBRICATING SINTERED SLIDING BEARINGS

MADE BY  
POWDER  
METALLURGY



**Modern bearing technology in sintered metal:**  
We have the right solution for you

# SINTERED SLIDING BEARINGS FROM GKN SINTER METALS

## GLOBAL MARKET LEADER

Sintered sliding bearings are an indispensable element of machinery, and GKN Sinter Metals is an expert in their development and production. Each year, we produce over one billion high-quality bearings for our customers.



Sintered sliding bearings from GKN Sinter Metals



## OVERVIEW OF MATERIALS

Sintered iron and sintered bronze with GKN Development and design expertise for optimum customer satisfaction



## SPECIAL FORMS

In addition to standard geometries such as cylindrical, flanged and spherical bearings, developments in powder metallurgy also enable complex geometries for special-purpose applications.

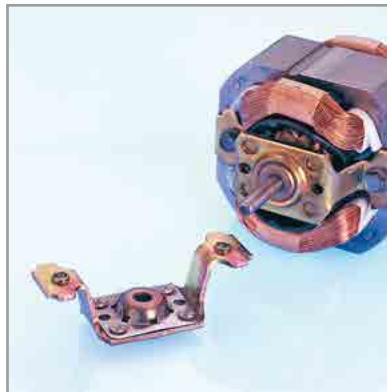

## FIELDS OF USE

Typical automotive applications include bearings for windshield wipers, window mechanisms, seat adjusters, sunroofs and fan motors. They can also be used in a variety of smaller electric motors and household actuators, in the consumer goods industry or in general mechanical engineering applications.



## MEASUREMENT ENGINEERING

- Oil content diagnostic/ soxhlet extraction
- Testing of sintered density in accordance with DIN EN 2738
- Infrared spectrum for lubricants
- Chemical analysis of sintered materials



Relevant experience in sintered sliding bearing technology



Very broad selection of available materials and lubricants



Special-purpose equipment compression molds, furnaces, handling, sizing, deburring and impregnation



Technical support for customers in the design and application of sintered bearings



Established development partner

# TECHNICAL PROPERTIES

## PROPERTIES OF SINTERED SLIDING BEARINGS

- Self-lubricating
- Require no maintenance
- High surface quality
- Strict tolerances
- Low sound output
- Almost zero material abrasion
- Cost efficiency benefits
- Flexible forms

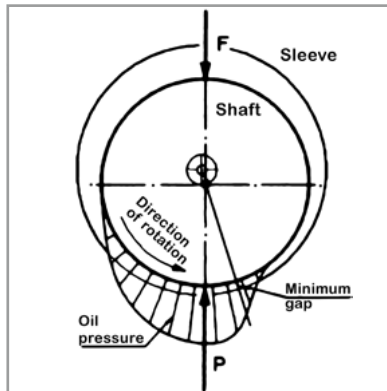

## MATERIAL & TESTING STATIONS

- Stribeck curve
- Temperature curve
- Sintered bearing operating stations
- Friction coefficient determination



## DESIGN

- We help with the selection of the right materials



## IN-LABORATORY SERVICE

- Analysis on motors
- Determination of remaining oil
- Pore distribution
- Roughness values
- Dimension testing
- Materials
- Bearing play
- Shaft properties



## THE STRIBECK CURVE

The Stribeck curve indicates friction as a function of linear or rotational speed. The hydrodynamic range represents the ideal operating conditions for sintered sliding bearings.

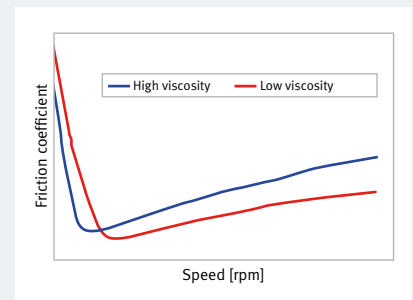

Friction coefficients relative to rotational speed

For applications that also function in mixed friction ranges, additional lubrication with solid lubricants is also possible.



Cylindrical bearing in the gear of a windscreen wiper drive mechanism

The viscosity of the lubricant also plays a critical role in defining the characteristic form of the Stribeck curve and consequently also the tribological system of the application.

# ABOUT THE PRODUCTION PROCESS

## SURFACE PROPERTIES

The microroughness of the bearing surface enables just the right amount of lubricant to be transferred. Tests have shown that surfaces that are too smooth or too polished can diminish the capacity and the life of the bearing.

To achieve the perfect surface properties for the intended function, the calibration of sintered surfaces offers fascinating opportunities.

For optimum lubricant storage while ensuring that the oil can circulate through the open pores, GKN determines the optimum calibration level for the applications in question.



Sintered surface

RPK  $\leq 3.5$

RK  $\leq 4.5$



Calibrated surface

RPK  $\leq 2$

RK  $\leq 2.5$

## PRODUCTION PROCESS OF SINTERED SLIDING BEARINGS

The bearing sizes start from an interior diameter of 0.8 millimeters and can go up to 150 millimeters.

Metal powder



Finished component



Impregnation

The calibration ensures that the specified tolerance, especially in the bore, is adhered to without closing the pores. The final step is impregnation under vacuum conditions using a suitable lubricant.

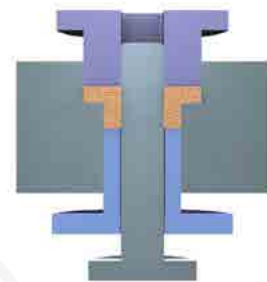

Calibration

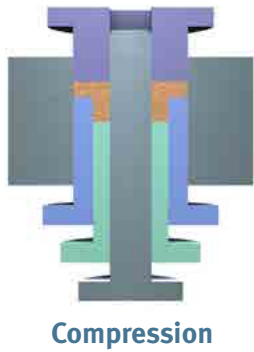

Compression



Sintering



Deburring

## TOLERANCES

Our sintered sliding bearings can be manufactured in accordance with the primary DIN, ISO and MPIF standards, but can also deviate from these to meet your requirements.

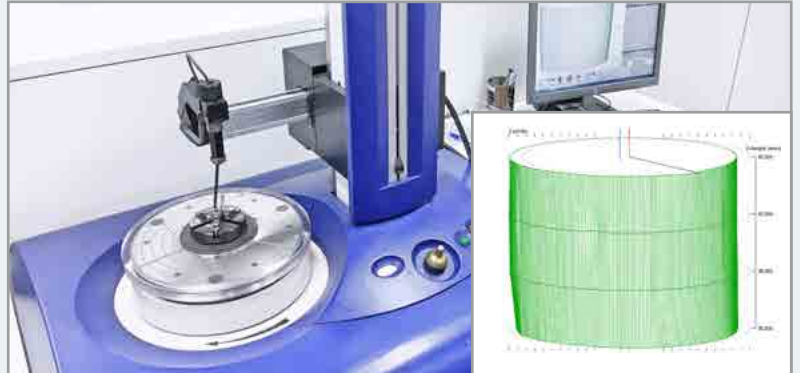

Apparatus to measure cylindrical form



Roughness measuring device

Some testing methods used to determine the surface properties of compact materials cannot be used with PM materials due to their porosity.

The surface roughness of PM components can be described with better accuracy and in particular better relevance to the given application using the Abbott curve.

## ROUGHNESS OF BEARING SURFACES

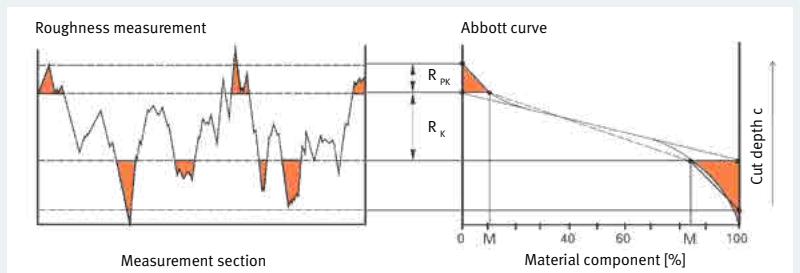

Abbott curve measured in accordance with DIN EN 13565.

# TRIBOLOGICAL SYSTEM

## ADDITION OF GRAPHITE

(for iron and bronze bearings)

Reduced running sounds, good emergency running properties

### ADDITIONAL LUBRICATION:

An additional lubricant reserve enables the service life to be increased considerably. The efficiency is significantly dependent on the chosen reservoir, such as oil-saturated felt.



Electric motor with spherical bearings and oil-saturated felt

## DRY BEARINGS WITH SOLID LUBRICANTS

Dry lubrication under certain circumstances can achieve better friction coefficients than plastic bearings and coated bearings, for instance.

### SOLID LUBRICANTS:

- Graphite
- MoS<sub>2</sub>
- Fe<sub>3</sub>O<sub>4</sub>

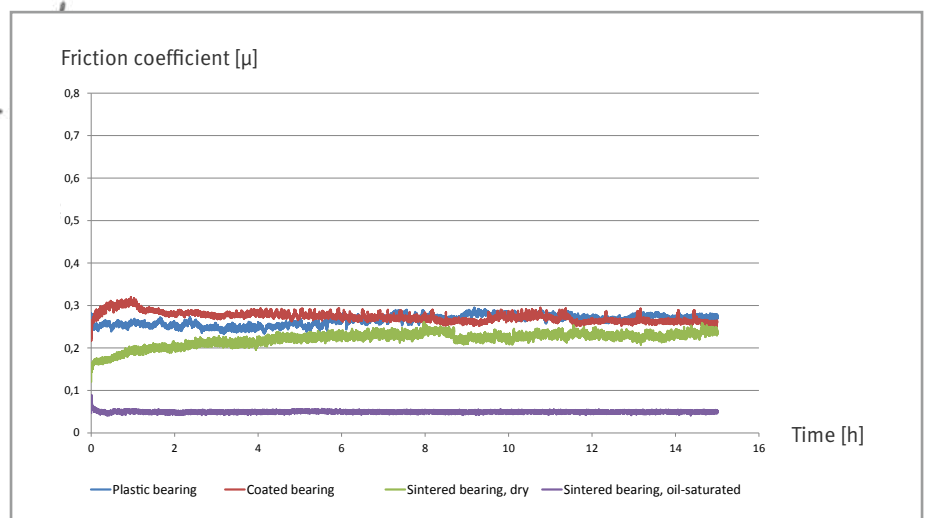

Friction values of different bearing types (determined under laboratory conditions on standard parts)

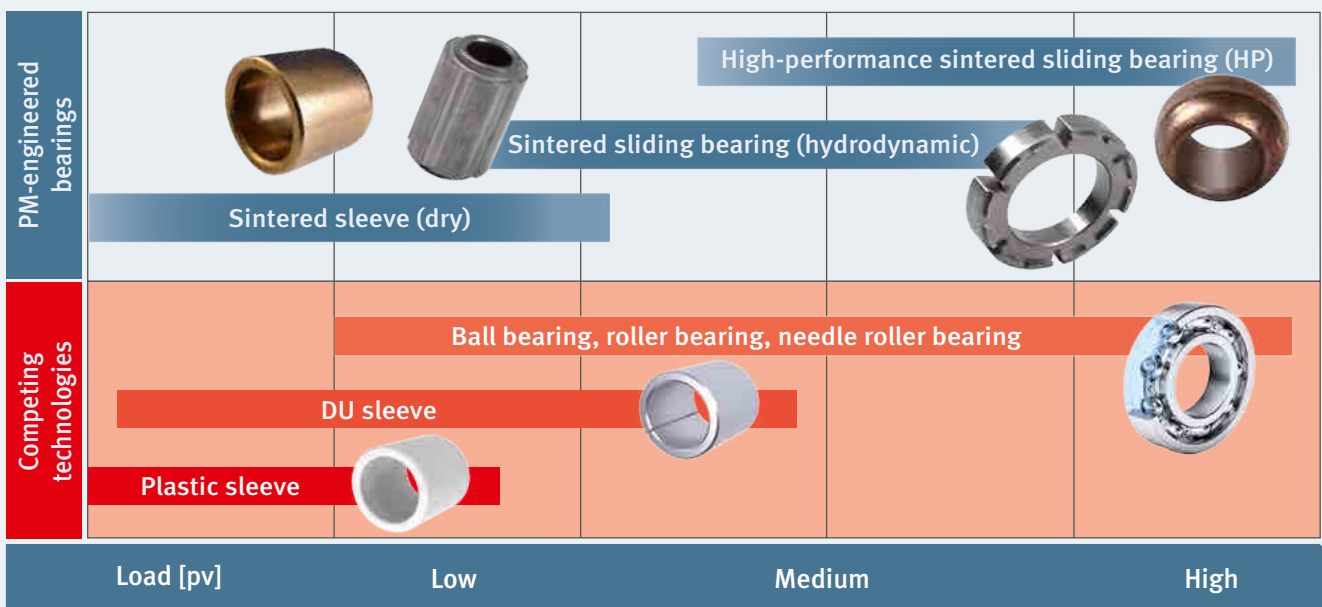

Possible range of applications for PM bearings compared with competitor technologies

# RANGE OF APPLICATIONS OF SINTERED BEARINGS

## SINTERED IRON

- High cost efficiency
- For conventional use
- Radial load up to 4 N/mm<sup>2</sup>(<sup>\*\*\*</sup>)
- Speed up to 2 m/s(<sup>\*\*\*</sup>)

(<sup>\*\*\*</sup>) Tested under laboratory conditions on standard parts

## BRONZE & BRONZE LIGHT\*

- Radial load up to 5 N/mm<sup>2</sup>(<sup>\*\*\*</sup>)
- Speed up to 3 m/s(<sup>\*\*\*</sup>)
- Good emergency running properties
- Stop & start operation
- Better corrosion resistance than iron(<sup>\*\*</sup>)

(\*) Lower-cost material mixture while maintaining constant performance

(<sup>\*\*</sup>) under the same environmental conditions (temperature, humidity, etc.)

## LOAD DIAGRAM

With critical requirements such as frequent stopping & starting, oscillating motion, superior heat discharge or anti-corrosion properties, we recommend the use of sintered bronze.

For highly cost-efficient applications and with more moderate corrosion resistance requirements, sintered irons can be used.

As the load diagram shows, the use of suitable materials enables the critical load curves to be moved up to higher values.

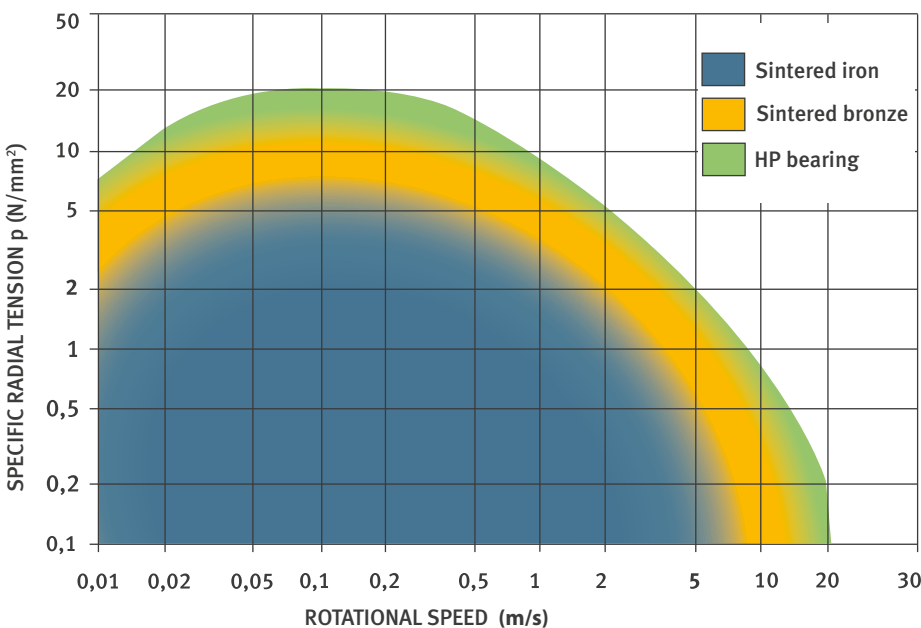

Limiting load diagram of sintered bearings (determined under laboratory conditions on standard parts)

## FROM PRECISION ENGINEERING TO HEAVY-DUTY INDUSTRIAL APPLICATIONS

Sintered sliding bearings have proven their value superbly for decades in all engineering disciplines. Their excellent bearing properties are significantly defined by the high level of precision in their manufacture and the porosity of the sintered material. Sintered bearings are deployed in almost all fields of industrial production, from simple guide bearings to high-load support bearings.

They range from minuscule bearings used in precision engineering to large-scale bearings in heavy-duty industry.

## TRIBOLOGICAL SYSTEM

The three fundamental factors of a tribological system:

- Main body (bearing)
- Transmission medium (lubricant)
- Opposing body (shaft)

Only a perfect constellation of these three factors can create a technically flawless solution.

# LIST OF LUBRICANTS

## PHYSICAL PROPERTIES

### VISCOSITY (FLOW PROPERTIES)

Viscosity is the internal friction (lubricant friction) of a fluid. Viscosity is a fundamental property that describes how thin or thick an oil is. The value is specified in units of  $\text{mm}^2/\text{s}$  at  $0\text{ }^\circ\text{C}$  and  $40\text{ }^\circ\text{C}$  (formerly cSt).

### VISCOSITY COEFFICIENT

These constants describe how dependent the viscosity is on temperature. It indicates the increase of viscosity relative to temperature. The lower it is (i.e. the flatter the viscosity/temperature curve), the better the viscosity/temperature properties of the oil.

### DENSITY

This value remains almost constant within a single group of lubricants. In general, density rises with increasing viscosity. Density is also no conclusive indication of quality; it is simply a means of classification, for instance.

### FLASHPOINT

The flashpoint defines the lowest temperature at which the oil fumes can catch fire as a result of an external ignition source.

### POUR POINT

The pour point defines the lowest temperature at which the lubricant still flows.

### COLOR

The oil color is no indication of its quality.

## LUBRICANT TYPES

### MINERAL OILS:

These are the most commonly used lubricants, not just because of their low prices, but also their good lubrication properties. They are used under bearing temperature conditions ranging from general  $-20$  bis  $+80\text{ }^\circ\text{C}$

### SYNTHETIC OILS:

These purely synthetic products are categorized into chemically very different groups. Their advantage lies in their high purity level – a result of the production process – and their greater material consistency compared to mineral oils. The use of selective additives enables the physical properties to be enhanced.

The most important groups are:

#### **Poly-alpha-olefins (synthetic hydrocarbons):**

These have a broad practical temperature range of  $-40$  to  $120\text{ }^\circ\text{C}$  and for brief periods of up to  $150\text{ }^\circ\text{C}$ .

Their fundamental chemical structure is similar to that of mineral oils, but they have a superior viscosity/temperature coefficient and high load capacity.

#### **Ester oils:**

These have a practical temperature range of  $-50$  to  $100\text{ }^\circ\text{C}$ . They have excellent wetting properties and are resistant to low temperatures. This lubricant can be aggressive on plastics and requires compatibility testing.

#### **Silicone oils:**

These have a broad practical temperature range of  $-60\text{ }^\circ\text{C}$  to  $+180\text{ }^\circ\text{C}$ . They have a high viscosity coefficient, meaning that it performs very well in its viscosity to temperature ratio. They are less resistant to stress than mineral oils. Silicone oils cannot be mixed with other oils.

Disadvantage: Flow properties

#### **Perfluorinated polyether oils:**

High-temperature lubricant oils for temperatures from  $-50\text{ }^\circ\text{C}$  to around  $200\text{ }^\circ\text{C}$ . They exhibit very low evaporation losses and are suitable for very long service lives at high temperatures.





	OIL TYPES	VISCOSITY AT 40°C (mm <sup>2</sup> /s)	POUR POINT (°C)	Practical temperature range (°C)
MINERAL OILS		68	-25	-20 ⇨ +80
		100	-20	-15 ⇨ +80
		150	-15	0 ⇨ +80
SYNTHETIC OILS	Poly-alpha-olefins	68	-50	-40 ⇨ +120
		100	-50	-40 ⇨ +120
		150	-50	-40 ⇨ +120
	Ester oils	68	-60	-50 ⇨ +100
		150	-50	-50 ⇨ +100
	Silicone oils	100	-65	-60 ⇨ +180
	Perfluorinated polyethers	150	-65	-50 ⇨ +200

Overview and properties of lubricants

## OTHER PHYSICAL PROPERTIES

### EVAPORATION LOSS

Evaporation loss is the weight loss of the oil expressed as a percentage when heated.

### PLASTIC COMPATIBILITY

When installing sliding bearings made of sintered metal in plastic housings, or when using axial thrust washers made of plastic, their compatibility with the lubricant must be tested beforehand.

## VISCOSITY DIAGRAM

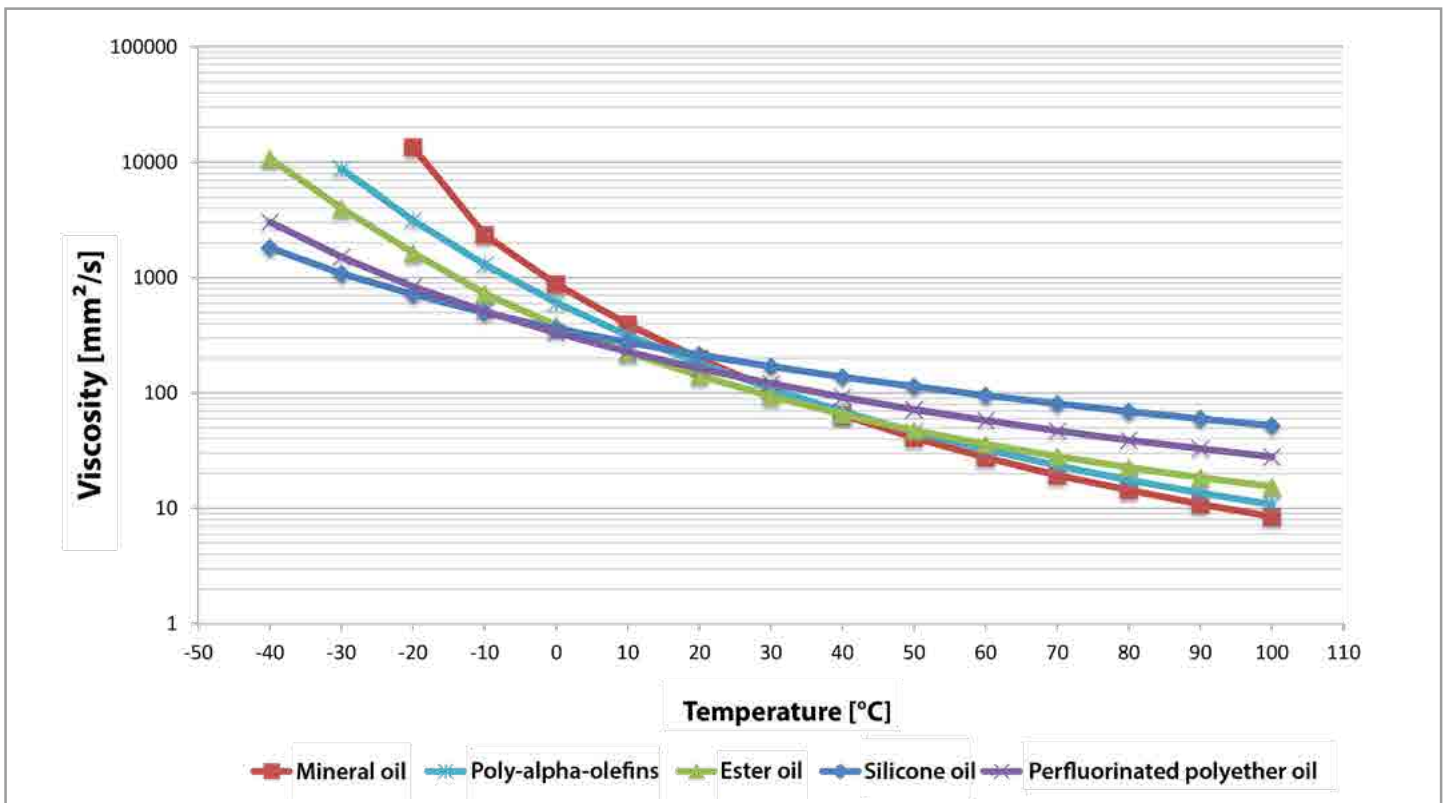

Viscosity relative to temperature for different oil types

# BEARING FORMS AND LUBRICANT CONTENT

## OIL CONTENT

Sintered bearings usually have a pore volume of 15-30 percent, and these pores are used as an oil reservoir for the bearing's entire service life. Mineral and synthetic oils are used for lubrication.

The lubricant reaches the friction area via the pores, with a system of balance developing over the course of the bearing's operation.

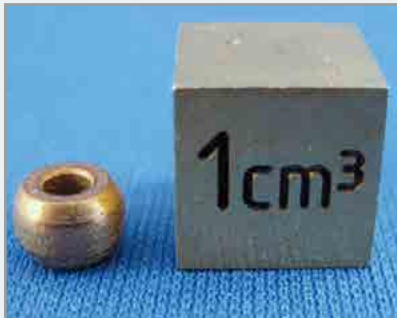

Example: Timer gear

Weight:	0.520 g
Porosity:	20%
Oil content:	0.0105 g
Service life:	10,000 h



Example: PC fan

Weight:	1.450 g
Porosity:	25%
Oil content:	0.040 g
Service life:	30,000 h



## CYLINDRICAL BEARINGS

This most cost-effective form of bearing is primarily pushed into a pre-processed bearing bore using a mandrel.



## FLANGE BEARINGS

Differ from cylindrical bearings with their flange on one side. This serves as a restraint during installation, and in certain cases, also serves as a larger support when placed under axial loads. This form of bearing also needs to be pushed in using a mandrel.



## SPHERICAL BEARINGS

Guarantees autonomous re-alignment of the bearing bore. The bore diameter remains unchanged when installing the spherical bearing. However, the installation is somewhat more complicated.



## SPHERICAL BEARING WITH EXTENSION

The main purpose of the extension is to compensate for any in-between spaces.

# SINTERED SLIDING BEARINGS QUESTIONNAIRE

Company .....

Company address .....

Telephone ..... Fax .....

Contact person .....

- 1) Bearing form .....
- 2) Bearing material .....
- 3) Bearing dimensions .....
- 4) Description of application .....
- .....
- .....
- .....
- 5) Installation orientation  horizontal .....  vertical .....
- 6) Mode of operation  uninterrupted .....  interrupted .....
- 7) Required service life ..... h 8) Speed ..... rpm
- 9) Lubricant reservoir  yes  no ..... 10) Oil type .....
- 11) Total bearing load (radial) ..... N 12) Specific ..... N/mm<sup>2</sup>
- 13) Bearing load (axial) ..... N
- 14) Bearing operating temperature ..... °C 15) Ambient temperature ..... °C

- 16) Shaft material ..... 17) Shaft hardness .....
- 18) Shaft roughness ..... μm
- 19) Housing material ..... 20) Bore tolerance .....
- 20) Misc. details .....
- .....
- .....
- .....

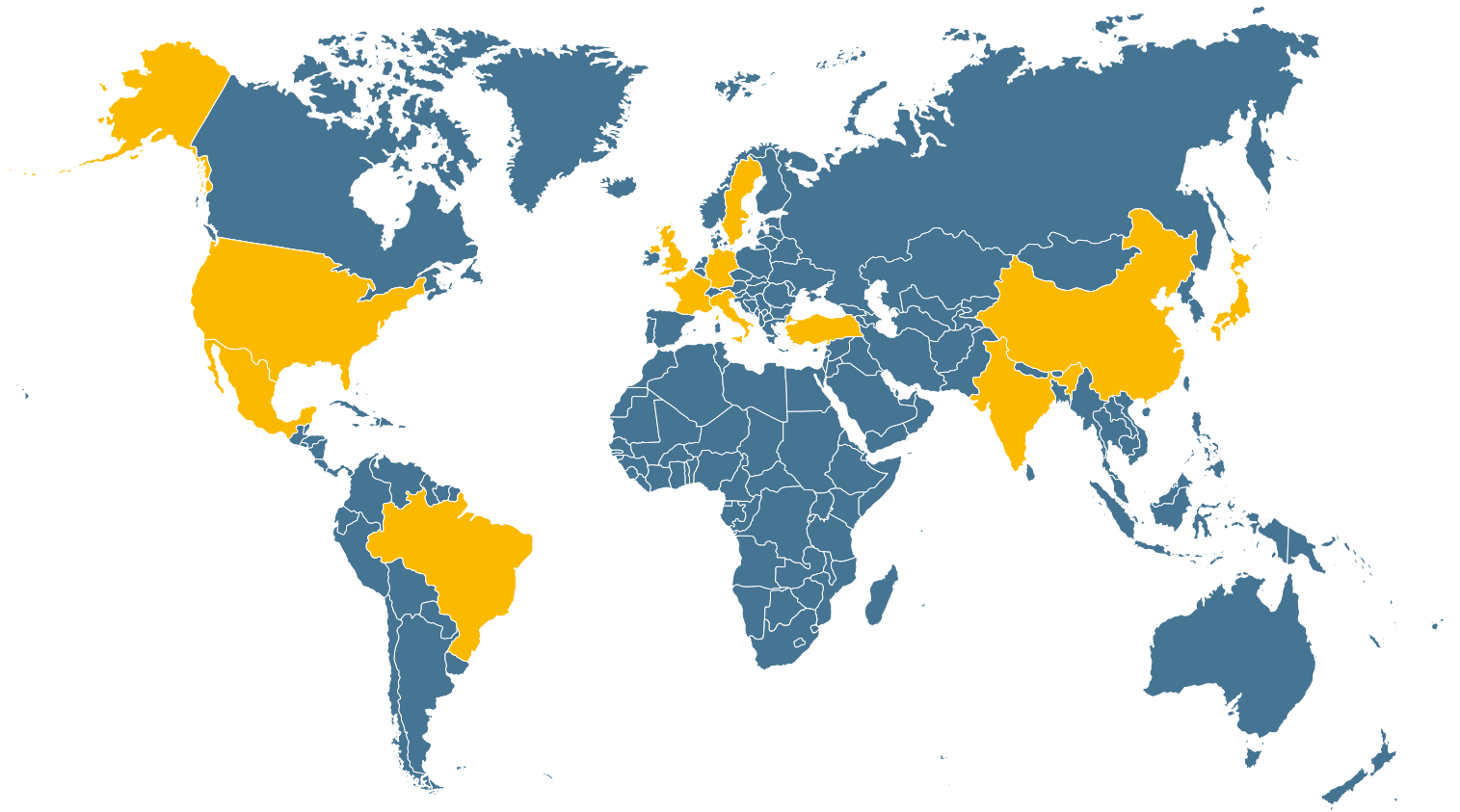

GKN Locations

**Over 30 locations  
in 12 countries  
on 4 continents**

For specific details and contact information please write to us at [contact@gknpm.com](mailto:contact@gknpm.com) or visit our website [www.gknpm.com](http://www.gknpm.com)

## GLOBAL SALES OFFICES

### AMERICAS

**USA**  
1670 Opdyke Court, Auburn Hills,  
MI 48326-2431, USA  
[infona@gknpm.com](mailto:infona@gknpm.com)

**MEXICO**  
Av. Dr. Jesús Valdés Sánchez, No. 104  
Parque Industrial Amistad Chuy María  
38194 Apaseo El Grande, Gto.  
[infomexico@gknpm.com](mailto:infomexico@gknpm.com)

**BRAZIL**  
Av. Emancipação, 4.500  
CEP 13186-542  
Hortolandia – SP, Brazil  
[infobrazil@gknpm.com](mailto:infobrazil@gknpm.com)

### ASIA

**CHINA**  
Suite 1105-1110, POS Plaza  
1600 Century Avenue  
Pudong, Shanghai 200122, China  
[infochina@gknpm.com](mailto:infochina@gknpm.com)

**INDIA**  
146 Mumbai - Pune Road  
Pimpri, Pune 411018  
Maharashtra, India  
[infoindia@gknpm.com](mailto:infoindia@gknpm.com)

**JAPAN**  
Senri Life Science Center Bldg. 12F  
1-4-2 ShinSenri Higashi-machi  
Toyonaka-city, Osaka, 560-0082  
Japan  
[infojapan@gknpm.com](mailto:infojapan@gknpm.com)

### EUROPE

**UNITED KINGDOM**  
Unit 7 Chestnut Court, Jill Lane  
Sambourne, Redditch  
Worcestershire, B96 6EW, UK  
[infouk@gknpm.com](mailto:infouk@gknpm.com)

**GERMANY**  
Krebsöge 10  
42 477 Radevormwald, Germany  
[infogermany@gknpm.com](mailto:infogermany@gknpm.com)

**ITALY**  
Fabrikstraße 5  
39 031 Bruneck (BZ), Italy  
[infoitaly@gknpm.com](mailto:infoitaly@gknpm.com)

**SWEDEN**  
Gothenburg, Sweden  
[infosweden@gknpm.com](mailto:infosweden@gknpm.com)

**FRANCE**  
6 Lotissement les Cruzettes  
38210 Tullins, France  
[infofrance@gknpm.com](mailto:infofrance@gknpm.com)

**TURKEY**  
Istanbul Ataturk Havalimani serbest bolgesi  
L Blok No:2  
34149 Yesilkoy-Istanbul/Turkey  
[infoturkey@gknpm.com](mailto:infoturkey@gknpm.com)